



# MLSE-0200A2NQ0

MLS

MAGNETIC SENSORS

**SICK**  
Sensor Intelligence.



### Ordering information

Type	part no.
MLSE-0200A2NQ0	1104468

Other models and accessories → [www.sick.com/MLS](http://www.sick.com/MLS)



### Detailed technical data

#### Features

<b>Detection range typ.</b>	200 mm
<b>Operating height</b>	10 mm ... 70 mm
<b>Electrical wiring</b>	DC 4-wire
<b>Enclosure rating</b>	IP65, IP67, IP68 <sup>1)</sup>

<sup>1)</sup> According to EN 60529.

#### Mechanics/electronics

<b>Supply voltage</b>	9 V DC ... 30 V DC
<b>Terminal resistor</b>	No internal terminator
<b>Protection class</b>	III
<b>Power consumption</b>	600 mW
<b>Resolution, typ.</b>	1 mm
<b>Repeat accuracy, typ.</b>	1 mm
<b>Update rate</b>	100 Hz
<b>Teach-in</b>	✓
<b>Reverse polarity protection</b>	Yes
<b>Short-circuit protection</b>	Yes
<b>Ambient operating temperature</b>	-20 °C ... +70 °C
<b>Shock and vibration resistance</b>	30 g, 11 ms/10 Hz ... 55 Hz, 1 mm
<b>EMC</b>	EN 61000-6-2, EN 61000-6-4
<b>Connection type</b>	Cable with M12 male connector, 4-pin, 0.3 m <sup>1)</sup>
<b>Connection type Detail</b>	

<sup>1)</sup> Do not bend below 0 °C.

Conductor cross section	0.08 mm <sup>2</sup>	
<b>Material</b>	Housing	Metal, Aluminum, plastic
	Cable	PUR
	<b>UL File No.</b>	NRKH.E181493 & NRKH7.E181493

<sup>1)</sup> Do not bend below 0 °C.

### Safety-related parameters

<b>MTTF<sub>D</sub></b>	143 years
<b>DC<sub>avg</sub></b>	0 %
<b>T<sub>M</sub> (mission time)</b>	20 years

### Communication interface

<b>Communication interface</b>	CANopen
--------------------------------	---------

### Diagnosis

<b>Orientation</b>	Number of axis	3
	Roll Euler angle measuring range	± 180°
	Pitch Euler angle measuring range	± 90°
	Yaw Euler angle measuring range	± 180°
	Resolution	0.02°
	Roll repeatability	± 1°
	Pitch repeatability	± 1°
	Yaw repeatability	± 1° <sup>1)</sup>
	Maximum rotation rate	2,000 °/s
	Quaternion w measuring range	0 ... + 1
	Quaternion x measuring range	-1 ... 1
	Quaternion y measuring range	-1 ... 1
	Quaternion z measuring range	-1 ... 1
	Update rate	100 Hz
	Limit frequency	100 Hz
	Initialization time	640 ms
	Sampling rate	200 Hz <sup>2)</sup>
	Acceleration measuring range	± 16 g <sup>2)</sup>
	Rotation rate measuring range	± 2,000 °/s <sup>2)</sup>

<sup>1)</sup> Not long-term stable.

<sup>2)</sup> Raw data.

### Certificates

<b>EU declaration of conformity</b>	✓
<b>UK declaration of conformity</b>	✓
<b>ACMA declaration of conformity</b>	✓
<b>Moroccan declaration of conformity</b>	✓

<b>China-RoHS</b>	✓
<b>cULus certificate</b>	✓
<b>CANopen certificate</b>	✓
<b>Information according to Art. 3 of Data Act (Regulation EU 2023/2854)</b>	✓

### Classifications

<b>ECLASS 5.0</b>	27270104
<b>ECLASS 5.1.4</b>	27270104
<b>ECLASS 6.0</b>	27270104
<b>ECLASS 6.2</b>	27270104
<b>ECLASS 7.0</b>	27270104
<b>ECLASS 8.0</b>	27270104
<b>ECLASS 8.1</b>	27270104
<b>ECLASS 9.0</b>	27270104
<b>ECLASS 10.0</b>	27270104
<b>ECLASS 11.0</b>	27270104
<b>ECLASS 12.0</b>	27274301
<b>ETIM 5.0</b>	EC002544
<b>ETIM 6.0</b>	EC002544
<b>ETIM 7.0</b>	EC002544
<b>ETIM 8.0</b>	EC002544
<b>UNSPSC 16.0901</b>	39122230

### Connection diagram Cd-396

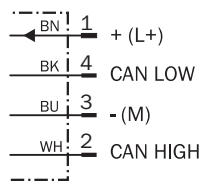

### Dimensional drawing

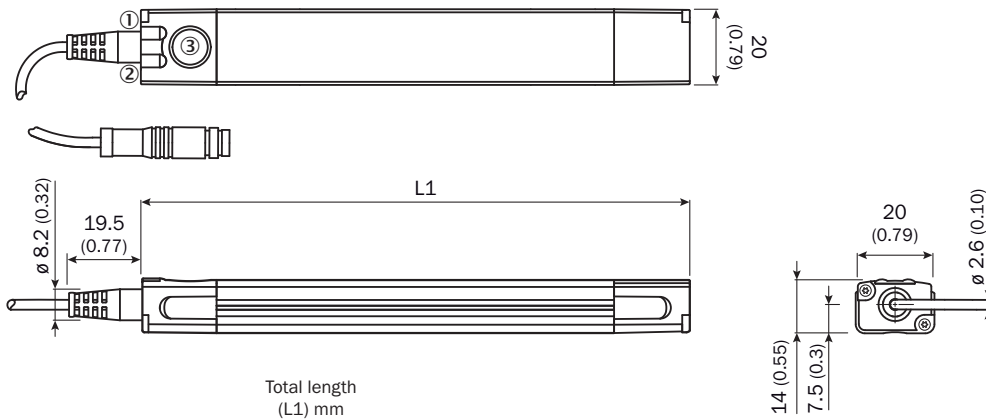



	Total length (L1) mm
<b>MLSE-0200</b>	217
<b>MLSE-0300</b>	325
<b>MLSE-0400</b>	397
<b>MLSE-0500</b>	505
<b>MLSE-0600</b>	613







Dimensions in mm (inch)





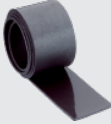





- ① Function signal indicator 1
- ② Function signal indicator 2
- ③ Teach-Pad

### Recommended accessories

Other models and accessories → [www.sick.com/MLS](http://www.sick.com/MLS)

	Brief description	Type	part no.
<b>Mounting systems</b>			
	<ul style="list-style-type: none"> <li><b>Description:</b> Bracket for lateral mounting</li> <li><b>Material:</b> Stainless steel, brass</li> <li><b>Details:</b> Stainless steel V2A (bracket/mounting screw), Brass (fixing screw)</li> <li><b>Usable for:</b> MPA-107 mm ... 251 mm (sensor measuring range), 2 (recommended number of brackets), MPA-287 mm ... 431 mm (measuring range sensor), 3 (recommended number mounting brackets), MPA-467 mm ... 647 mm (measuring range sensor), 4 (recommended number mounting brackets), MPA-683 mm ... 791 mm (measuring range sensor), 5 (recommended number mounting brackets), MPA-827 mm ... 1007 mm (measuring range sensor), 6 (recommended number mounting brackets)</li> </ul>	BEF-WNZ01MPA	2065577
	<ul style="list-style-type: none"> <li><b>Description:</b> Bracket for low mounting</li> <li><b>Material:</b> Stainless steel, brass</li> <li><b>Details:</b> Stainless steel V2A (bracket/mounting screw), Brass (fixing screw)</li> <li><b>Usable for:</b> MPA-107 mm ... 251 mm (sensor measuring range), 2 (recommended number of brackets), MPA-287 mm ... 431 mm (measuring range sensor), 3 (recommended number mounting brackets), MPA-467 mm ... 647 mm (measuring range sensor), 4 (recommended number mounting brackets), MPA-683 mm ... 791 mm (measuring range sensor), 5 (recommended number mounting brackets), MPA-827 mm ... 1007 mm (measuring range sensor), 6 (recommended number mounting brackets)</li> </ul>	BEF-WNLO1MPA	2065973

	Brief description	Type	part no.
magnets			
	<ul style="list-style-type: none"> <li><b>Product segment:</b> Magnets</li> <li><b>Product:</b> Magnetic tapes</li> <li><b>Description:</b> Magnetic tape, North is top side, adhesive, width 25 mm, length 50 m</li> </ul>	MAGNETIC TAPE	5337613
	<ul style="list-style-type: none"> <li><b>Product segment:</b> Magnets</li> <li><b>Product:</b> Magnetic tapes</li> <li><b>Description:</b> Magnetic tape, South is top side, adhesive, width 25 mm, length 50 m</li> </ul>	MAGNETIC TAPE	5337614
	<ul style="list-style-type: none"> <li><b>Product segment:</b> Magnets</li> <li><b>Product:</b> Magnetic tapes</li> <li><b>Description:</b> Magnetic tape, north pole on top, self-adhesive, width = 25mm, external length = 524 mm, internal length = 511 mm, radius = 1000 mm, 30° section</li> </ul>	Magnetic tape, curved	5344198
	<ul style="list-style-type: none"> <li><b>Product segment:</b> Magnets</li> <li><b>Product:</b> Magnetic tapes</li> <li><b>Description:</b> Magnetic tape, South is top side, adhesive, width 25 mm, length 50 m</li> </ul>	MAGNETIC TAPE	5350884
	<ul style="list-style-type: none"> <li><b>Product segment:</b> Magnets</li> <li><b>Product:</b> Magnetic tapes</li> <li><b>Description:</b> Magnetic tape, North is top side, adhesive, width 25 mm, length 50 m</li> </ul>	MAGNETBAND	5350883
Commissioning aids and test equipment			
	<ul style="list-style-type: none"> <li><b>Product:</b> Alignment aids</li> <li><b>Description:</b> Positioning device for magnetic markers (5337613, 5337614) for MLS</li> </ul>	TEMPLATE	4097520

	Brief description	Type	part no.
connectors and cables			
	<ul style="list-style-type: none"> <li>• <b>Connection type head A:</b> Female connector, M12, 4-pin, straight, A-coded</li> <li>• <b>Connection type head B:</b> Flying leads</li> <li>• <b>Signal type:</b> Sensor/actuator cable</li> <li>• <b>Cable:</b> 2 m, 4-wire, PUR, halogen-free</li> <li>• <b>Description:</b> Sensor/actuator cable, unshielded</li> <li>• <b>Application:</b> Uncontaminated zones, Zones with oils and lubricants, Robot, Drag chain operation</li> </ul>	YF2A14-020UB3XLEAX	2095607
	<ul style="list-style-type: none"> <li>• <b>Connection type head A:</b> Female connector, M12, 4-pin, straight, A-coded</li> <li>• <b>Connection type head B:</b> Flying leads</li> <li>• <b>Signal type:</b> Sensor/actuator cable</li> <li>• <b>Cable:</b> 5 m, 4-wire, PUR, halogen-free</li> <li>• <b>Description:</b> Sensor/actuator cable, unshielded</li> <li>• <b>Application:</b> Uncontaminated zones, Zones with oils and lubricants, Robot, Drag chain operation</li> </ul>	YF2A14-050UB3XLEAX	2095608
	<ul style="list-style-type: none"> <li>• <b>Connection type head A:</b> Female connector, M12, 4-pin, angled, A-coded</li> <li>• <b>Connection type head B:</b> Flying leads</li> <li>• <b>Signal type:</b> Sensor/actuator cable</li> <li>• <b>Cable:</b> 2 m, 4-wire, PUR, halogen-free</li> <li>• <b>Description:</b> Sensor/actuator cable, unshielded</li> <li>• <b>Application:</b> Uncontaminated zones, Zones with oils and lubricants, Robot, Drag chain operation</li> </ul>	YG2A14-020UB3XLEAX	2095766
	<ul style="list-style-type: none"> <li>• <b>Connection type head A:</b> Female connector, M12, 4-pin, angled, A-coded</li> <li>• <b>Connection type head B:</b> Flying leads</li> <li>• <b>Signal type:</b> Sensor/actuator cable</li> <li>• <b>Cable:</b> 5 m, 4-wire, PUR, halogen-free</li> <li>• <b>Description:</b> Sensor/actuator cable, unshielded</li> <li>• <b>Application:</b> Uncontaminated zones, Zones with oils and lubricants, Robot, Drag chain operation</li> </ul>	YG2A14-050UB3XLEAX	2095767
	<ul style="list-style-type: none"> <li>• <b>Application:</b> Zones with chemicals, Uncontaminated zones</li> </ul>	YF8U14-011VA3FYDN2	2098412
	<ul style="list-style-type: none"> <li>• <b>Connection type head A:</b> Female connector, M12, 4-pin, straight, A-coded</li> <li>• <b>Connection type head B:</b> Flying leads</li> <li>• <b>Signal type:</b> Sensor/actuator cable</li> <li>• <b>Cable:</b> 0.6 m, 4-wire, PUR, halogen-free</li> <li>• <b>Description:</b> Sensor/actuator cable, unshielded</li> <li>• <b>Application:</b> Uncontaminated zones, Zones with oils and lubricants, Robot, Drag chain operation</li> </ul>	YF2A14-C60UB3XLEAX	2145654
	<ul style="list-style-type: none"> <li>• <b>Connection type head A:</b> Female connector, M12, 4-pin, straight, A-coded</li> <li>• <b>Connection type head B:</b> Flying leads</li> <li>• <b>Signal type:</b> Sensor/actuator cable</li> <li>• <b>Cable:</b> 1 m, 4-wire, PUR, halogen-free</li> <li>• <b>Description:</b> Sensor/actuator cable, unshielded</li> <li>• <b>Application:</b> Uncontaminated zones, Zones with oils and lubricants, Robot, Drag chain operation</li> </ul>	YF2A14-010UB3XLEAX	2145655
	<ul style="list-style-type: none"> <li>• <b>Connection type head A:</b> Female connector, M12, 4-pin, straight, A-coded</li> <li>• <b>Connection type head B:</b> Flying leads</li> <li>• <b>Signal type:</b> Sensor/actuator cable</li> <li>• <b>Cable:</b> 3 m, 4-wire, PUR, halogen-free</li> <li>• <b>Description:</b> Sensor/actuator cable, unshielded</li> <li>• <b>Application:</b> Uncontaminated zones, Zones with oils and lubricants, Robot, Drag chain operation</li> </ul>	YF2A14-030UB3XLEAX	2145656
	<ul style="list-style-type: none"> <li>• <b>Connection type head A:</b> Female connector, M12, 4-pin, angled, A-coded</li> <li>• <b>Connection type head B:</b> Flying leads</li> <li>• <b>Signal type:</b> Sensor/actuator cable</li> <li>• <b>Cable:</b> 0.6 m, 4-wire, PUR, halogen-free</li> <li>• <b>Description:</b> Sensor/actuator cable, unshielded</li> <li>• <b>Application:</b> Uncontaminated zones, Zones with oils and lubricants, Robot, Drag chain operation</li> </ul>	YG2A14-C60UB3XLEAX	2145657
	<ul style="list-style-type: none"> <li>• <b>Connection type head A:</b> Female connector, M12, 4-pin, angled, A-coded</li> <li>• <b>Connection type head B:</b> Flying leads</li> <li>• <b>Signal type:</b> Sensor/actuator cable</li> <li>• <b>Cable:</b> 1 m, 4-wire, PUR, halogen-free</li> <li>• <b>Description:</b> Sensor/actuator cable, unshielded</li> <li>• <b>Application:</b> Uncontaminated zones, Zones with oils and lubricants, Robot, Drag chain operation</li> </ul>	YG2A14-010UB3XLEAX	2145658
integration modules and adapters			
	<ul style="list-style-type: none"> <li>• <b>Description:</b> CAN-USB Adapter to connect MLS with a PC</li> </ul>	AKA-NXL1BXB12KX	6067651

## SICK AT A GLANCE

SICK is one of the leading manufacturers of intelligent sensors and sensor solutions for industrial applications. A unique range of products and services creates the perfect basis for controlling processes securely and efficiently, protecting individuals from accidents and preventing damage to the environment.

We have extensive experience in a wide range of industries and understand their processes and requirements. With intelligent sensors, we can deliver exactly what our customers need. In application centers in Europe, Asia and North America, system solutions are tested and optimized in accordance with customer specifications. All this makes us a reliable supplier and development partner.

Comprehensive services complete our offering: SICK LifeTime Services provide support throughout the machine life cycle and ensure safety and productivity.

For us, that is “Sensor Intelligence.”

## WORLDWIDE PRESENCE:

Contacts and other locations –[www.sick.com](http://www.sick.com)