



# WLA26P-24162100A00

## W26

PHOTOELECTRIC SENSORS

**SICK**  
Sensor Intelligence.



Illustration may differ

### Ordering information

Type	part no.
WLA26P-24162100A00	1218664

Other models and accessories → [www.sick.com/W26](http://www.sick.com/W26)



### Detailed technical data

#### Features

<b>Functional principle</b>	Photoelectric retro-reflective sensor
<b>Functional principle detail</b>	Without reflector minimum distance (autocollimation/coaxial optics)
<b>Sensing range</b>	
Sensing range min.	0 m
Sensing range max.	18 m
Maximum distance range from reflector to sensor (operating reserve 1)	0 m ... 18 m
Recommended distance range from reflector to sensor (operating reserve 3,75)	0 m ... 12 m
Reference reflector	Reflector PL80A
Recommended sensing range for the best performance	0 m ... 12 m
<b>Polarisation filters</b>	Yes
<b>Emitted beam</b>	
Light source	PinPoint LED
Type of light	Visible red light
Shape of light spot	Point-shaped
Light spot size (distance)	Ø 100 mm (10 m)
Maximum dispersion of the emitted beam around the standardized transmission axis (squint angle)	< +/- 1.0° (at Ta = +23 °C)

<b>Key LED figures</b>		
Normative reference		EN 62471:2008-09   IEC 62471:2006, modified
LED risk group marking		Free group
Wave length		635 nm
Average service life		100,000 h at $T_a = +25 \text{ }^\circ\text{C}$
<b>Adjustment</b>		
	IO-Link	For configuring the sensor parameters and Smart Task functions
<b>Display</b>		
	LED blue	BluePilot: Alignment aid
	LED green	Operating indicator Static on: power on Flashing: IO-Link mode
	LED yellow	Status of received light beam Static on: object not present Static off: object present Flashing: Below the 1.5 function reserve
<b>Special applications</b>		Detecting objects wrapped in film

### Safety-related parameters

<b>MTTF<sub>D</sub></b>	690 years
<b>DC<sub>avg</sub></b>	0%
<b>T<sub>M</sub> (mission time)</b>	20 years

### Communication interface

<b>IO-Link</b>		✓, V1.1
	Data transmission rate	COM2 (38,4 kBaud)
	Cycle time	2.3 ms
	Process data length	16 Bit
	Process data structure	Bit 0 = switching signal Q <sub>L1</sub> Bit 1 = switching signal Q <sub>L2</sub> Bit 2 ... 15 = empty
	VendorID	26
	DeviceID HEX	0x800180
	DeviceID DEC	8388992
	Compatible master port type	A
	SIO mode support	Yes

### Electronics

<b>Supply voltage U<sub>B</sub></b>	10 V DC ... 30 V DC <sup>1)</sup>
<b>Ripple</b>	≤ 5 V <sub>pp</sub>
<b>Usage category</b>	DC-12 (According to EN 60947-5-2) DC-13 (According to EN 60947-5-2)
<b>Current consumption</b>	≤ 30 mA, without load. At U <sub>B</sub> = 24 V
<b>Protection class</b>	III
<b>Digital output</b>	

<sup>1)</sup> Limit values.

<sup>2)</sup> Signal transit time with resistive load in switching mode.

<sup>3)</sup> With light/dark ratio 1:1.

<sup>4)</sup> This switching output must not be connected to another output.

Number	2 (Complementary)
Type	Push-pull: PNP/NPN
Switching mode	Light/dark switching
Signal voltage PNP HIGH/LOW	Approx. $U_B - 2.5 \text{ V} / 0 \text{ V}$
Signal voltage NPN HIGH/LOW	Approx. $U_B / < 2.5 \text{ V}$
Output current $I_{\text{max}}$	$\leq 100 \text{ mA}$
Circuit protection outputs	Reverse polarity protected Overcurrent and short-circuit protected
Response time	$\leq 500 \mu\text{s}$ <sup>2)</sup>
Repeatability (response time)	150 $\mu\text{s}$
Switching frequency	1,000 Hz <sup>3)</sup>
<b>Pin/Wire assignment</b>	
Function of pin 4/black (BK)	Digital output, light switching, object present → output $Q_{L1}$ LOW; IO-Link communication C <sup>4)</sup>
Function of pin 4/black (BK) – detail	The pin 4 function of the sensor can be configured Additional possible settings via IO-Link
Function of pin 2/white (WH)	Digital output, dark switching, object present → output $\bar{Q}_{L1}$ HIGH <sup>4)</sup>
Function of pin 2/white (WH) – detail	The pin 2 function of the sensor can be configured Additional possible settings via IO-Link

<sup>1)</sup> Limit values.

<sup>2)</sup> Signal transit time with resistive load in switching mode.

<sup>3)</sup> With light/dark ratio 1:1.

<sup>4)</sup> This switching output must not be connected to another output.

## Mechanics

<b>Housing</b>	Rectangular
<b>Dimensions (W x H x D)</b>	24.6 mm x 82.5 mm x 53.3 mm
<b>Connection</b>	Male connector M12, 4-pin
<b>Material</b>	
Housing	Plastic, VISTAL®
Front screen	Plastic, PMMA
Male connector	Plastic, VISTAL®
<b>Weight</b>	Approx. 80 g
<b>Maximum tightening torque of the fixing screws</b>	1.3 Nm

## Ambient data

<b>Enclosure rating</b>	IP66 (EN 60529) IP67 (EN 60529) IP69 (EN 60529) <sup>1)</sup>
<b>Ambient operating temperature</b>	-40 °C ... +60 °C
<b>Ambient temperature, storage</b>	-40 °C ... +75 °C
<b>Shock resistance</b>	50 g, 11 ms (25 positive and 25 negative shocks per axis, for X, Y, Z axes, 150 shocks in total (EN60068-2-27))

<sup>1)</sup> Replaces IP69K with ISO 20653: 2013-03.

	50 g, 6 ms (5,000 positive and 5,000 negative shocks per axis, for X, Y, Z axes, 30,000 shocks in total (EN60068-2-27))
<b>Vibration resistance</b>	10 Hz ... 2,000 Hz (Amplitude 0.5 mm / 10 g, 20 sweeps per axis, for X, Y, Z axes, 1 octave/min, (EN60068-2-6))
<b>Air humidity</b>	35 % ... 95 %, relative humidity (no condensation)
<b>Electromagnetic compatibility (EMC)</b>	EN 60947-5-2
<b>Resistance to cleaning agent</b>	ECOLAB
<b>UL File No.</b>	NRKH.E181493 & NRKH7.E181493

<sup>1)</sup> Replaces IP69K with ISO 20653: 2013-03.

## Smart Task

<b>Smart Task name</b>	Base logics
<b>Logic function</b>	Direct AND OR Window Hysteresis
<b>Timer function</b>	Deactivated Switch-on delay Off delay ON and OFF delay Impulse (one shot)
<b>Inverter</b>	Yes
<b>Switching frequency</b>	SIO Logic: 800 Hz <sup>1)</sup> IOL: 650 Hz <sup>2)</sup>
<b>Response time</b>	SIO Logic: 600 µs <sup>1)</sup> IOL: 750 µs <sup>2)</sup>
<b>Repeatability</b>	SIO Logic: 300 µs <sup>1)</sup> IOL: 400 µs <sup>2)</sup>
<b>Switching signal</b>	
Switching signal $Q_{L1}$	Switching output
Switching signal $\bar{Q}_{L1}$	Switching output

<sup>1)</sup> Use of Smart Task functions without IO-Link communication (SIO mode).

<sup>2)</sup> Use of Smart Task functions with IO-Link communication function.

## Diagnosis

<b>Device status</b>	Yes
<b>Quality of teach</b>	Yes
<b>Quality of run</b>	Yes, Contamination display

## Certificates

<b>EU declaration of conformity</b>	✓
<b>UK declaration of conformity</b>	✓
<b>ACMA declaration of conformity</b>	✓
<b>Moroccan declaration of conformity</b>	✓
<b>China-RoHS</b>	✓
<b>ECOLAB certificate</b>	✓
<b>cULus certificate</b>	✓

<b>IO-Link</b>	✓
<b>Photobiological safety (DIN EN 62471) certificate</b>	✓
<b>Information according to Art. 3 of Data Act (Regulation EU 2023/2854)</b>	✓

### Classifications

<b>ECLASS 5.0</b>	27270902
<b>ECLASS 5.1.4</b>	27270902
<b>ECLASS 6.0</b>	27270902
<b>ECLASS 6.2</b>	27270902
<b>ECLASS 7.0</b>	27270902
<b>ECLASS 8.0</b>	27270902
<b>ECLASS 8.1</b>	27270902
<b>ECLASS 9.0</b>	27270902
<b>ECLASS 10.0</b>	27270902
<b>ECLASS 11.0</b>	27270902
<b>ECLASS 12.0</b>	27270902
<b>ETIM 5.0</b>	EC002717
<b>ETIM 6.0</b>	EC002717
<b>ETIM 7.0</b>	EC002717
<b>ETIM 8.0</b>	EC002717
<b>UNSPSC 16.0901</b>	39121528

### Dimensional drawing, sensor

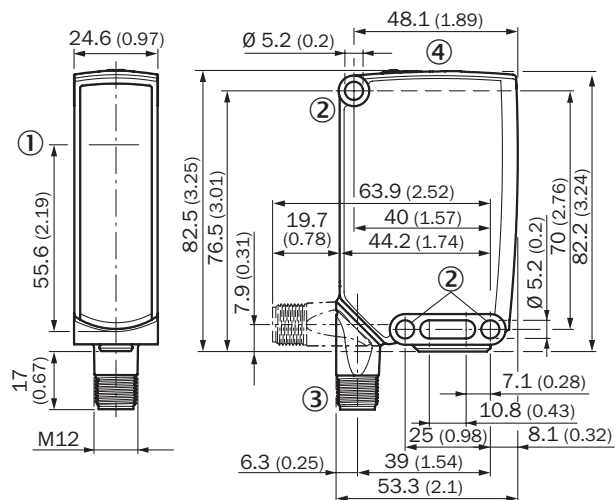

Dimensions in mm (inch)

- ① Center of optical axis
- ② Mounting hole,  $\varnothing$  5.2 mm
- ③ Connection
- ④ display and adjustment elements

display and adjustment elements



- ① LED indicator green
- ② LED indicator yellow
- ③ LED blue

Connection type M12 male connector, 4-pin

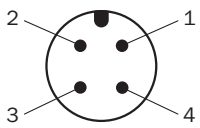

Connection diagram Cd-390

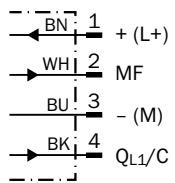

### Truth table Push-pull: PNP/NPN – dark switching $\bar{Q}$

	Dark switching $\bar{Q}$ (normally open (upper switch), normally closed (lower switch))	
	Object not present → Output LOW	Object present → Output HIGH
Light receive	✓	✗
Light receive indicator	☀	✗
Load resistance to L+	⚡	✗
Load resistance to M	✗	⚡

### Truth table Push-pull: PNP/NPN - light switching Q

	Light switching Q (normally closed (upper switch), normally open (lower switch))	
	Object not present → Output HIGH	Object present → Output LOW
Light receive	✓	✗
Light receive indicator	☀	✗
Load resistance to L+	✗	⚡
Load resistance to M	⚡	✗

### Characteristic curve Fine triple reflectors

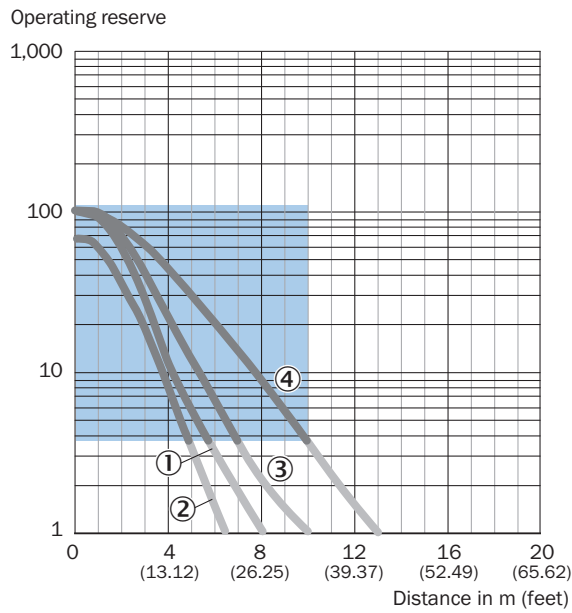

Recommended sensing range for the best performance

- ① PL10FH-1 reflector
- ② PL10F reflector
- ③ Reflector PL20F
- ④ Reflector P250F

### Characteristic curve Chemical-resistant reflectors

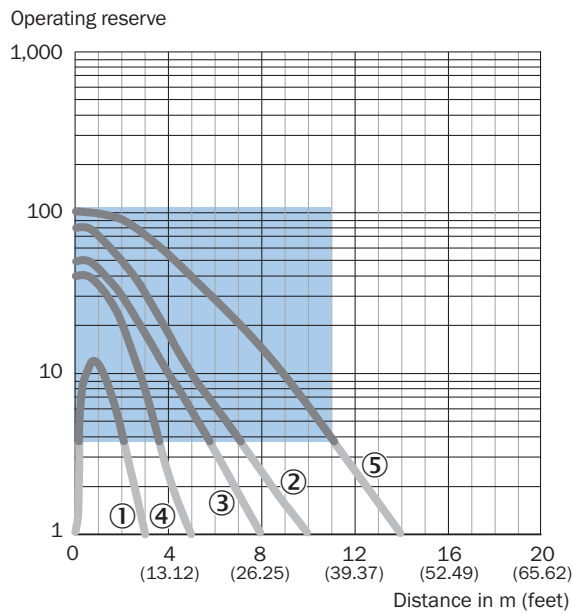

Recommended sensing range for the best performance

- ① PL10F CHEM reflector
- ② Reflector P250H
- ③ Reflector P250 CHEM
- ④ Reflector PL20 CHEM

⑤ Reflector PL40A Antifog

Characteristic curve Standard reflectors

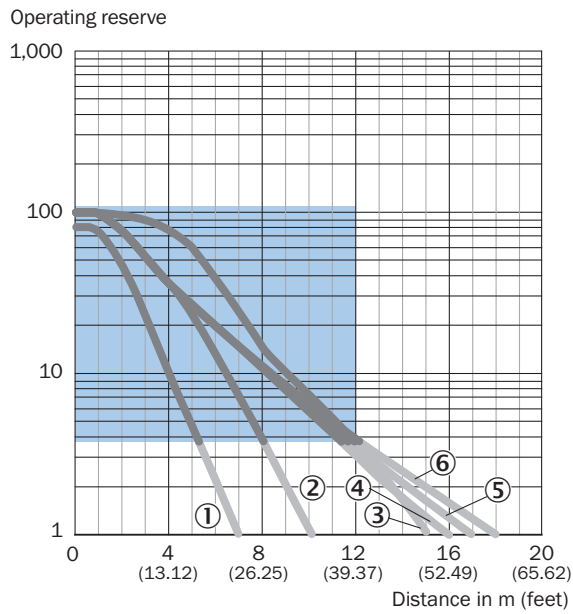

■ Recommended sensing range for the best performance

- ① Reflector PL20A
- ② Reflector PL22
- ③ Reflector PL250
- ④ Reflector PL30A
- ⑤ Reflector PL40A
- ⑥ Reflector PL80A, C110A

Characteristic curve Reflective tape

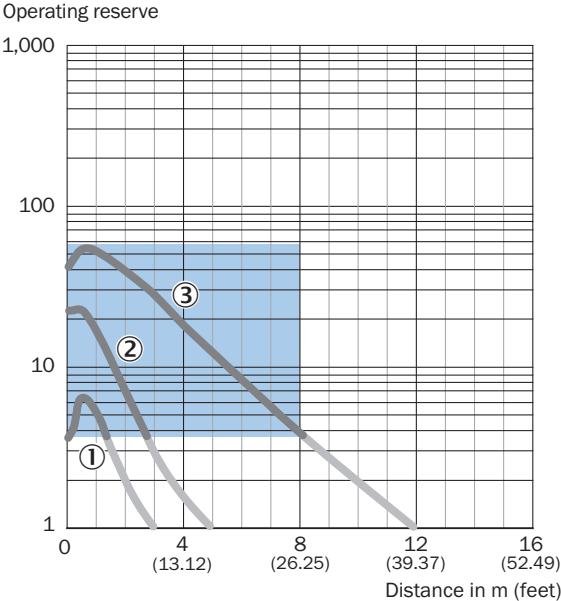

- Recommended sensing range for the best performance
- ① Reflective tape REF-DG (50 x 50 mm)
- ② Reflective tape REF-IRF-56 (50 x 50 mm)
- ③ Reflective tape REF-AC1000 (50 x 50 mm)

Light spot size WLA26P-xxxx1xx

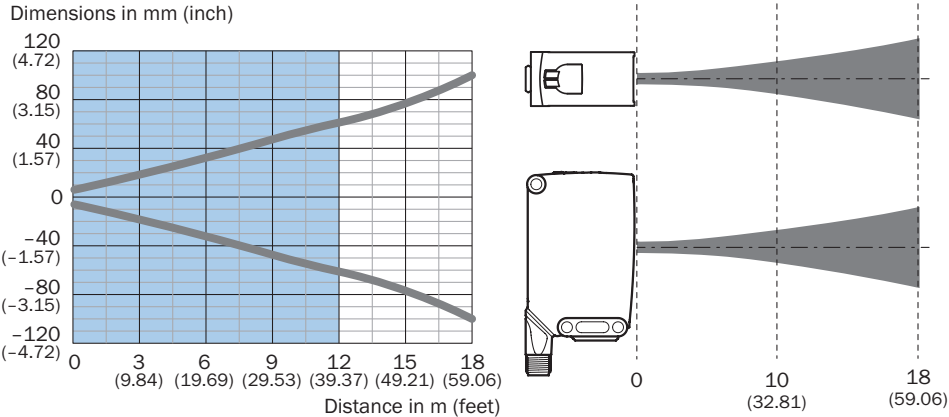

■ Recommended sensing range for the best performance

Sensing range diagram Reflective tape

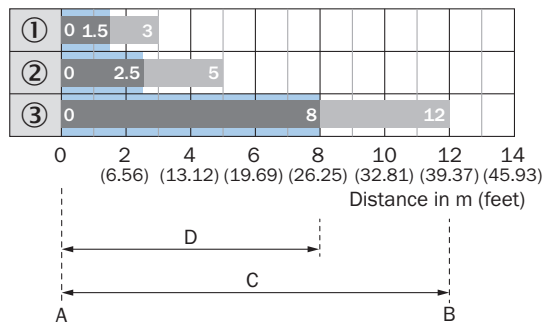

Recommended sensing range for the best performance

1	Reflective tape REF-DG (50 x 50 mm)
2	Reflective tape REF-IRF-56 (50 x 50 mm)
3	Reflective tape REF-AC1000 (50 x 50 mm)
A	Sensing range min. in m
B	Sensing range max. in m
C	Maximum distance range from reflector to sensor (operating reserve 1)
D	Recommended distance range from reflector to sensor (operating reserve 3,75)

Sensing range diagram Chemical-resistant reflectors

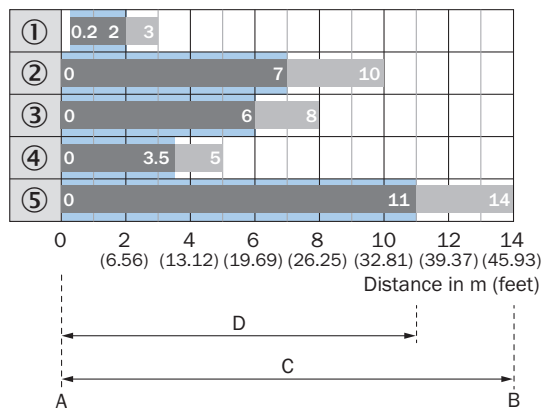

Recommended sensing range for the best performance

1	PL10F CHEM reflector
2	Reflector P250H
3	Reflector P250 CHEM
4	Reflector PL20 CHEM
5	Reflector PL40A Antifog
A	Sensing range min. in m
B	Sensing range max. in m

C	Maximum distance range from reflector to sensor (operating reserve 1)
D	Recommended distance range from reflector to sensor (operating reserve 3,75)

Sensing range diagram Fine triple reflectors

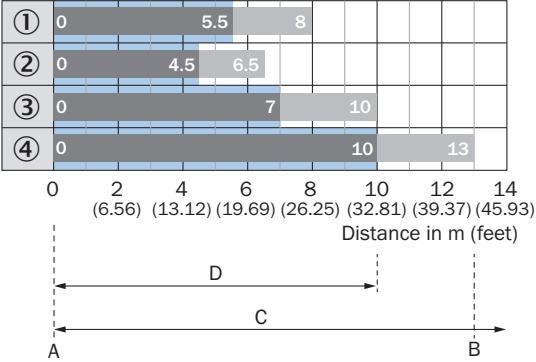

Recommended sensing range for the best performance

1	PL10FH-1 reflector
2	PL10F reflector
3	Reflector PL20F
4	Reflector P250F
A	Sensing range min. in m
B	Sensing range max. in m
C	Maximum distance range from reflector to sensor (operating reserve 1)
D	Recommended distance range from reflector to sensor (operating reserve 3,75)

Sensing range diagram Standard reflectors

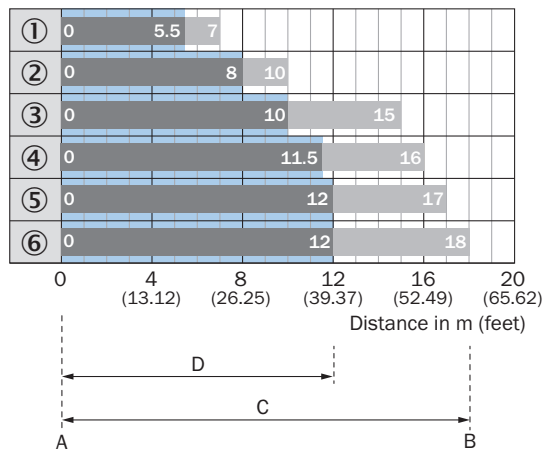

Recommended sensing range for the best performance

1	Reflector PL20A
2	Reflector PL22
3	Reflector P250
4	Reflector PL30A
5	Reflector PL40A
6	Reflector PL80A, C110A
A	Sensing range min. in m
B	Sensing range max. in m
C	Maximum distance range from reflector to sensor (operating reserve 1)
D	Recommended distance range from reflector to sensor (operating reserve 3,75)

Functions Operation note

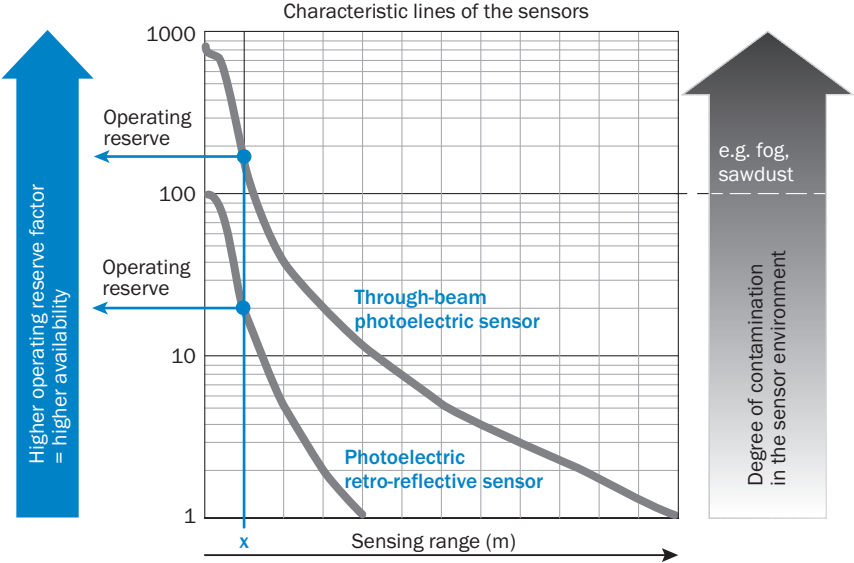

At a sensing range of „x“ the photoelectric retro-reflective and through-beam photoelectric sensors have different operating reserves (see blue arrow). The higher the operating reserve factor, the better the sensor can compensate the contamination in the air or in the light beam and on the optical surfaces (front screen, reflector), i.e. the sensor has the maximum availability, otherwise the sensor switches due to pollution although there is no object in the path of the light beam.

Functions Operation note





BluePilot: Blue indicator LEDs with double benefits

<p>Easy and quick sensor alignment with the help of the LED indicator</p> <p>All blue LEDs illuminate</p> <ul style="list-style-type: none"> <li>- optimum alignment</li> <li>- highest possible operating reserve</li> </ul>	<p><b>WLA photoelectric retro-reflection sensor alignment</b></p>
<p><b>Service note</b></p> <p>A reduction in sensor availability is displayed by a decrease of the blue LEDs.</p> <p>Possible causes:</p> <ol style="list-style-type: none"> <li>insufficient alignment</li> <li>contamination of the optical surfaces</li> <li>particles in the light beam</li> </ol>	

### Recommended accessories

Other models and accessories → [www.sick.com/W26](http://www.sick.com/W26)

	Brief description	Type	part no.
Mounting systems			
	<ul style="list-style-type: none"> <li><b>Description:</b> Mounting bracket with hinged arm</li> <li><b>Material:</b> Steel</li> <li><b>Details:</b> Steel, zinc coated</li> <li><b>Items supplied:</b> Mounting hardware included</li> <li><b>Suitable for:</b> W23-2, W27-3, Reflex Array</li> </ul>	BEF-WN-W27	2009122
	<ul style="list-style-type: none"> <li><b>Description:</b> Plate N12 for universal clamp. For mounting PL30A, P250 reflectors, W27 and WTR2 sensors.</li> <li><b>Material:</b> Steel, zinc diecast</li> <li><b>Details:</b> Zinc plated steel (sheet), Zinc die cast (clamping bracket)</li> <li><b>Items supplied:</b> Universal clamp (2022726), mounting hardware</li> <li><b>Usable for:</b> W26, Reflex Array, P250, W23-2, W27-3, W27-3</li> </ul>	BEF-KHS-N12	2071950
	<ul style="list-style-type: none"> <li><b>Description:</b> Mounting bracket with articulated arm</li> <li><b>Material:</b> Steel</li> <li><b>Details:</b> Steel, zinc coated</li> <li><b>Items supplied:</b> Mounting hardware included</li> <li><b>Suitable for:</b> W16, W26, W11, W12, W23, W27, Dx50, W280, G10</li> </ul>	BEF-WN-MULTI2	2093945
	<ul style="list-style-type: none"> <li><b>Description:</b> Mounting bracket</li> <li><b>Material:</b> Steel</li> <li><b>Details:</b> Steel, zinc coated</li> <li><b>Items supplied:</b> Mounting hardware included</li> <li><b>Suitable for:</b> W23-2, W27-3, Reflex Array</li> </ul>	BEF-WN-W23	2019085
	<ul style="list-style-type: none"> <li><b>Description:</b> Universal mounting bracket for reflectors</li> <li><b>Dimensions (W x H x L):</b> 85 mm x 90 mm x 35 mm</li> <li><b>Material:</b> Steel</li> <li><b>Details:</b> Steel, zinc coated</li> <li><b>Suitable for:</b> C110A, P250, PL20, PL30A, PL40A, PL80A</li> </ul>	BEF-WN-REFX	2064574
	<ul style="list-style-type: none"> <li><b>Description:</b> Plate N11N for universal clamp bracket</li> <li><b>Material:</b> Stainless steel</li> <li><b>Details:</b> Stainless steel 1.4571 (sheet), Stainless steel 1.4408 (clamp)</li> <li><b>Items supplied:</b> Universal clamp (5322627), mounting hardware</li> <li><b>Usable for:</b> DeltaPac, Glare, WTD20E</li> </ul>	BEF-KHS-N11N	2071081

	Brief description	Type	part no.
reflectors and optics			
	<ul style="list-style-type: none"> <li><b>Description:</b> Rectangular, screw connection</li> <li><b>Dimensions:</b> 84 mm 84 mm</li> <li><b>Ambient operating temperature:</b> -30 °C ... +65 °C</li> </ul>	PL80A	1003865
connectors and cables			
	<ul style="list-style-type: none"> <li><b>Connection type head A:</b> Male connector, M12, 4-pin, straight, A-coded</li> <li><b>Description:</b> Unshielded</li> <li><b>Connection systems:</b> Screw-type terminals</li> <li><b>Permitted cross-section:</b> ≤ 0.75 mm<sup>2</sup></li> </ul>	STE-1204-G	6009932
	<ul style="list-style-type: none"> <li><b>Connection type head A:</b> Female connector, M12, 4-pin, straight, A-coded</li> <li><b>Connection type head B:</b> Flying leads</li> <li><b>Signal type:</b> Sensor/actuator cable</li> <li><b>Cable:</b> 5 m, 4-wire, PVC</li> <li><b>Description:</b> Sensor/actuator cable, unshielded</li> <li><b>Application:</b> Zones with chemicals, Uncontaminated zones</li> </ul>	YF2A14-050VB3XLEAX	2096235
	<ul style="list-style-type: none"> <li><b>Connection type head A:</b> Female connector, M12, 4-pin, straight, A-coded</li> <li><b>Connection type head B:</b> Flying leads</li> <li><b>Signal type:</b> Sensor/actuator cable</li> <li><b>Cable:</b> 5 m, 4-wire, PUR, halogen-free</li> <li><b>Description:</b> Sensor/actuator cable, unshielded</li> <li><b>Application:</b> Uncontaminated zones, Zones with oils and lubricants, Robot, Drag chain operation</li> </ul>	YF2A14-050UB3XLEAX	2095608

## SICK AT A GLANCE

SICK is one of the leading manufacturers of intelligent sensors and sensor solutions for industrial applications. A unique range of products and services creates the perfect basis for controlling processes securely and efficiently, protecting individuals from accidents and preventing damage to the environment.

We have extensive experience in a wide range of industries and understand their processes and requirements. With intelligent sensors, we can deliver exactly what our customers need. In application centers in Europe, Asia and North America, system solutions are tested and optimized in accordance with customer specifications. All this makes us a reliable supplier and development partner.

Comprehensive services complete our offering: SICK LifeTime Services provide support throughout the machine life cycle and ensure safety and productivity.

For us, that is “Sensor Intelligence.”

## WORLDWIDE PRESENCE:

Contacts and other locations –[www.sick.com](http://www.sick.com)